

# Principles of Autonomic Medicine

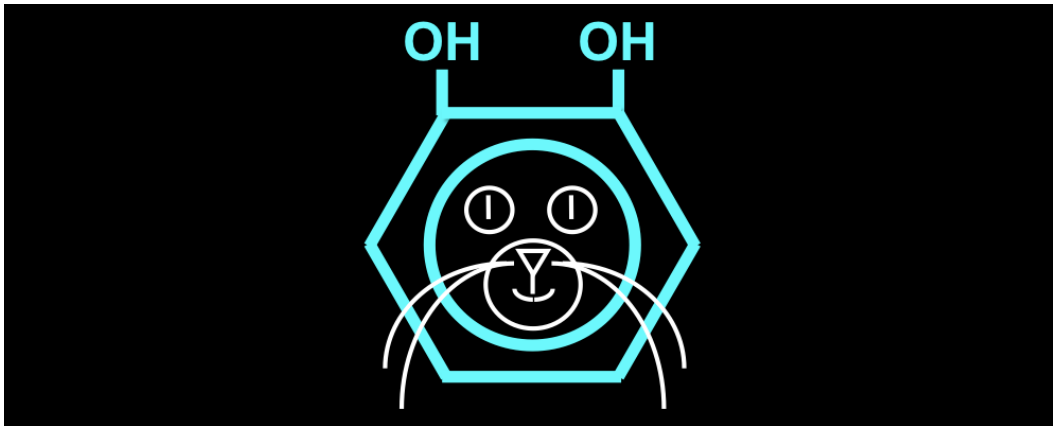
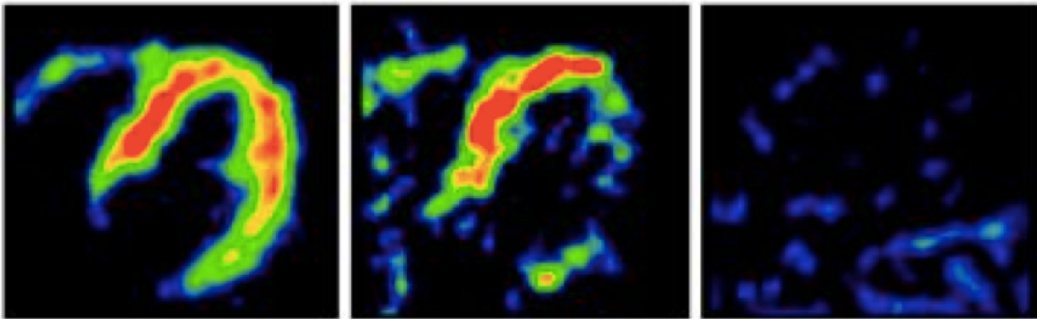

David S. Goldstein, MD PhD

## **DISCLAIMERS**

This work was produced as an Official Duty Activity while the author was an employee of the United States Government. The text and original figures in this book are in the public domain and may be distributed or copied freely. Use of appropriate byline or credit is requested. For reproduction of copyrighted material, permission by the copyright holder is required.

The views and opinions expressed here are those of the author and do not necessarily state or reflect those of the United States Government or any of its components.

References in this book to specific commercial products, processes, services by trade name, trademark, manufacturer, or otherwise do not necessarily constitute or imply their endorsement, recommendation, or favoring by the United States Government or its employees.

The appearance of external hyperlinks is provided with the intent of meeting the mission of the National Institute of Neurological Disorders and Stroke. Such appearance does not constitute an endorsement by the United States Government or any of its employees of the linked web sites or of the information, products or services contained at those sites. Neither the United States Government nor any of its employees, including the author, exercise any editorial control over the information that may be found on these external sites.

Permissions were obtained from the following for reproduction of pictures in this book. Other reproduced pictures were from Wikipedia Commons.

Tootsie Roll Industries, LLC (Tootsie Roll Pop, p. 33)

The Ross Ashby Digital Archive [www.rossashby.info](http://www.rossashby.info) (Ashby's homeostat, p. 62)

Credit Fabio Campana/European Pressphoto Agency (portrait of Rita Levi-Montalcini, p. 127)

Dr. Paul Greengard (portrait photo, p. 130)

Dr. Robert Lefkowitz (portrait photo, p. 132)

Dr. Brian Kobilka (portrait photo, p. 132)

American Journal of Pediatrics (Beighton score examples, p. 310)

American Physiological Society (tracing of skeletal muscle sympathetic nerve traffic, p. 331)

Dr. Stephen G. Kaler (photos of Menkes disease patient, p. 410)

Elsevier (electrocardiographic tracing, p. 420; baropacer, p. 451)

Medtronic 2015 (Symplicity device, p. 449)

CVRx (carotid sinus stimulator, p. 451)

Getty Images (photo of Venus Williams, p. 488)

PolioPlace.org (photo of Dr. Albert Sabin, p. 494)

Dr. Eva Mezey (photo of Lewy body, p. 502)

Morton Kondracke (cover of the book, Saving Milly, p. 521)

Rick Friedman/The New York Times/Redux (photo of Dr. Thomas Graboys, p. 558)

## DEDICATION

I dedicate this book to my family, for their support and understanding; my colleagues and friends at the NIH, for their devotion to our research mission and to me; and especially to the many patients who have put their trust in me and provided me with sparkles of insight about how the body's "automatic" systems function in health and disease.

I've benefited from a rich network of NIH colleagues, whom I have cherished for their sharing time with me in a common quest for truth and meaning. Some of these, in alphabetical order, are: Ines Armando, John Bacher, Krys Bankiewicz, Oladi Benthoo, Alan Breier, Richard Cannon, Peter Chang, Glen Cook, Adele Cooney, Nadir Dakak, Raghu Dendi, Ray Dionne, Yu-Fe Duan, Graeme Eisenhofer, Basil Eldadah, Igor Elman, Giora Feuerstein, John Finberg, Joan Folio, Steve Frank, Koki Fukuhara, Moshe Garty, John Gill, Anna Golczynska, Phil Gold, Ehud Grossman, Aaron Hoffman, Courtney Holmes, Thanh Huynh, Richard Imrich, Yunden Jinsmaa, Steve Kaler, Harry Keiser, Joong-Seok Kim, Ken Kirk, Irv Kopin, Richard Kvetnansky, Ray Lake, Itzhak Lamensdorf, Jacques Lenders, Paul Levinson, Shengting Li, Roshanak Mansouri, Jeff Moak, Alex Neumeister, Karel Pacak, Miki Palkovits, Mee Yeong Park, Jigisha Patel, Sandra Pechnik, Ron Polinsky, Faisal Rachman, LaToya Sewell, Yoni Sharabi, Ellen Sidransky, Cathy Sims-O'Neil, John Stuhlmuller,

Robin Stull, Patti Sullivan, Kate Szemeredi, Cees Tack, Dnyanesh Tipre, Olga Tjurmina, Alex Vortmeyer, Efrat Wolfovitz, Gal Yadid, Reuven Zimlichman, and Zofia Zukowska.

I especially thank Irv Kopin, my mentor. As Chief of the Laboratory of Clinical Science at the National Institute of Mental Health, then as Scientific Director of the National Institute of Neurological Disorders and Stroke, and now as Scientist Emeritus, he has been an example of intellectual rigor, productivity, perspective, and integrity, an inspiration throughout my career at the NIH. Irv, may we continue to argue with each other for many more years.

Courtney Holmes, who has worked with me for more than a quarter century, runs our Section's Clinical Neurochemistry Laboratory. Courtney is the Cal Ripken of catechol assays. Cal played infield for baseball's Baltimore Orioles for 19 years. He was famous for his amazing consistency (2,632 consecutive games played) and virtually flawless fielding (2 Golden Glove awards). He made it look easy, because of his attention to detail, work ethic, and monumental expertise. Courtney has the same qualities. She unerringly points me to the truth. If there were a catecholamine Hall of Fame, Courtney would surely be voted in.

Finally, I remember with awe, respect, and appreciation the patients who requested they be autopsied to enhance understanding of their disease—the ultimate act of philanthropy. They have been some of

my greatest teachers. I feel honored and humbled to name them here:  
Norman Allred, Elva Blake, Stanley Fried, Stephanos Hatzivassiliou,  
Daphne Hughes, Milly Kondracke, Jose Montalvo, Bernard Parrette,  
Frank Robbins, Robert Sawyer, and Kathleen Spring.

<b>TABLE OF CONTENTS</b>	<b>7</b>
<b>INTRODUCTION</b>	<b>12</b>
The View from Building 10	12
Patients as a Scientific Resource	14
Why Did I Write this Book?	15
What is Different about this Book?	16
Dis-auto-NO-mias and Cat-a-COLA-means	18
Why are Dysautonomias So Hard?	20
<b>WHAT IS THE AUTONOMIC NERVOUS SYSTEM?</b>	<b>30</b>
<b>THE TOOTSIE ROLL POP</b>	<b>33</b>
The CNS is Like a Tootsie Roll Pop	33
The Autonomic Nervous System Isn't Autonomic	34
The Utility Pole Outside Your House	37
<b>HISTORY OF THE "AUTOMATIC" NERVOUS SYSTEM</b>	<b>42</b>
On the Risk of Being a Physician's Son	42
What's in a Name?	44
Langley's "Autonomic Nervous System"	47
The Heart of a Frog	52
The Fat above the Kidneys	54
Dale's Sympathetic Cholinergic System	57
Bernard's "Inner World"	57
Cannon's "Homeostasis"	59
Ashby's "Homeostat"	62
Selye's "Stress"	65
Homeostats and the ANS	67
<b>ORGANIZATION OF THE ANS</b>	<b>73</b>
Distribution of the ANS in the Body	74
The Central Autonomic Network	98
Summary of the Organization of the ANS	100
<b>HOW DOES THE ANS WORK?</b>	<b>105</b>
<b>GETTING THE MESSAGE ACROSS</b>	<b>106</b>
Chemical Messengers of the ANS: An Introduction	106
The Search for the Omega Sign	117
Pretty Woman	120
<b>CATECHOLS LOOK LIKE CATS</b>	<b>123</b>
The Nobel Chemicals	124
Cannon's Ingenious Experiment	132
Why Catechols Look Like Cats	134

Of Mice and Men and Wine and Cheese	155
RECEPTORS	181
Mushrooms and Tobacco	181
"First I Secreted a Hell of a Lot of Adrenaline"	187
STRESS, DISTRESS, AND THE ANS	193
Stress and Allostatic Load	193
Differential SNS & SAS Responses to Stressors	197
Distress	199
The Sleeper Hold	219
An Amazing Cooking Experiment	229
Sweet Urine	231
Lose Weight Fast!	233
An Unusual Weight-lifting Feat	234
A Little Pain Can't Hurt	237
<b>WHAT ARE DYSAUTONOMIAS?</b>	<b>239</b>
IN DYSAUTONOMIAS, WHAT GOES WRONG?	240
The Ironic Case of John Hunter	244
WHEN IN LIFE DO DYSAUTONOMIAS OCCUR?	247
HOW ARE DYSAUTONOMIAS CLASSIFIED?	252
CONDITIONS ASSOCIATED WITH AUTONOMIC FAILURE	254
CONDITIONS ASSOCIATED WITH AUTONOMIC STIMULATION	260
WHAT IS ORTHOSTATIC HYPOTENSION?	264
WHAT IS ORTHOSTATIC INTOLERANCE?	269
WHAT ARE THE SYMPTOMS AND SIGNS OF DYSAUTONOMIAS?	274
<b>TESTS FOR DYSAUTONOMIAS</b>	<b>281</b>
OVERVIEW OF AUTONOMIC FUNCTION TESTS	283
THE MOST IMPORTANT TEST OF ALL	291
Timing is Everything	293
Symptoms & Signs of Dysautonomias	295
Composite Autonomic Symptom Score (COMPASS)	300
A Pain in the Neck	304
Who Does Your Shopping?	305
Pretzel Legs and the Water Bottle Sign	306
A Bit of a Stretch	308
PHYSIOLOGICAL TESTS	311
The Valsalva Maneuver	311
Tilt Table Testing	317
Sweat Tests	321
Forearm Blood Flow	326



Sympathetic Microneurography	329
Pupillometry	330
Heart Rate Variability	338
Ambulatory Blood Pressure Monitoring	342
The Cold Pressor Test	343
Composite Autonomic Severity Scale	344
DRUG TESTS	345
Tyramine	345
Ganglion Blockade	347
Clonidine	351
Yohimbine	352
Isoproterenol	356
Glucagon	359
131I-Albumin to Measure Blood Volume	360
BIOCHEMICAL TESTS	363
The Cat Comes Back	363
Antibody Tests	378
NEUROIMAGING TESTS	381
Cardiac Sympathetic Neuroimaging	382
Striatal Dopaminergic Neuroimaging	387
SKIN BIOPSIES	390
GENETIC TESTS	393
Familial Dysautonomia	393
DBH Deficiency	393
NET Deficiency	393
Menkes Disease	394
WHICH TESTS ARE DONE WHERE?	394
<b>STARS IN THE DYSAUTONOMIAS UNIVERSE</b>	<b>396</b>
<b>INHERITED OR CONGENITAL DYSAUTONOMIAS</b>	<b>400</b>
Familial Dysautonomia	401
Diseases of Catecholamine Synthesis	403
The NET Result	414
Catecholaminergic Polymorphic Ventricular Tachycardia (CPVT)	416
<b>AUTONOMICALLY MEDIATED SYNCOPE</b>	<b>418</b>
Sympathoadrenal Imbalance	422
Do Snakes Faint?	425
Fainting While Lecturing to Autonomics Experts	429
DIABETES	430
HYPERTENSION	433
Carotid Sinus Stimulation	446

Renal Nerve Ablation	448
Pheochromocytoma (Pheo)	449
POSTURAL TACHYCARDIA SYNDROME (POTS)	456
The Key is the "S"	458
Primary vs. Secondary Causes of POTS	459
Blood Volume and POTS	460
Grinch Syndrome	462
Neuropathic POTS	464
Hyperadrenergic Orthostatic Intolerance	465
POTS with Autonomically Mediated Syncope	468
Comparing Apples and Pears	469
POTS Treatment	472
STRESS CARDIOPATHY	473
HEART FAILURE	478
SJOGREN'S SYNDROME	483
AMYLOIDOSIS	485
GUILLAIN-BARRÉ SYNDROME	487
The Sabin Affair	489
The Swine Flu Affair	491
BAROREFLEX FAILURE	492
AUTONOMIC SYNUCLEINOPATHIES	496
Multiple System Atrophy (MSA)	507
Pure Autonomic Failure (PAF)	517
Parkinson Disease (PD)	525
Dementia with Lewy Bodies	547
ACQUIRED AUTONOMIC FAILURE	557
Autoimmune Autonomic Ganglionopathy (AAG)	557
<b>MANAGING DYSAUTONOMIAS</b>	<b>562</b>
OVERVIEW	563
TREATMENT OF DYSAUTONOMIAS	564
The Most Effective Treatments	564
Non-Drug Treatments	565
Drug Treatments	572
LIVING WITH DYSAUTONOMIAS	594
Finding and Working with a Physician	594
Day by Day with Dysautonomia	599
Referral to an Autonomic Specialist	612
Caregiving and Support	616
<b>IDEAS FOR THE FUTURE</b>	<b>624</b>

MIND-BODY DISORDERS	627
THE CHANGING FACE OF DISEASE	632
SCIENTIFIC INTEGRATIVE MEDICINE	634
Linking Systems Biology with Integrative Medicine	635
Systems and Regulation of the Inner World	638
Catecholamine Autotoxicity	644
THE FUTURE IS NOW	654
Flipping the Clinic	656
<b>GLOSSARY</b>	<b>659</b>

# INTRODUCTION

## The View from Building 10

I sit in an office/lab in Building 10, the Clinical Center of the National Institutes of Health—“the NIH”—in Bethesda, Maryland. The yellow arrow shows where I am. Building 10, with the added on Hatfield Clinical Research Center, is the largest research hospital on earth.



*Building 10, the NIH Clinical Center, in Bethesda, MD.*

Titans of academic medicine have passed through Building 10 during

their training. I came here fresh from internal medicine residency in 1978. I've been here ever since.

I've been in Building 10 so long, it occupies me. In this textbook I'll be presenting autonomic medicine from the viewpoint of a clinical researcher. In Building 10 I've been privileged to develop many clinical laboratory techniques relevant to autonomic disorders and apply them for the first time in patients.

The combination of new technology with the availability of patients who have rare but informative disorders sets the stage for inducing new concepts as the data come in.

In this respect I feel like I am continuing a tradition that goes back to William Harvey, the father of modern medical research, who wrote in 1657, "Nature is nowhere accustomed more openly to display her secret mysteries than in cases where she shows traces of her workings apart from the beaten path; nor is there any better way to advance the proper practice of medicine than to give our minds to the discovery of the usual law of nature, by the careful investigation of cases of rarer forms of disease. For it has been found in almost all things, that what they contain of use or of application, is hardly perceived unless we are deprived of them, or they become deranged in some way."

I hope to share the excitement that comes from making medical scientific discoveries and to convey the historical, cultural, and

societal significance of an extraordinary field of knowledge: the autonomic nervous system.

## **Patients as a Scientific Resource**

The type of research I do is called patient-oriented research. In patient-oriented research you try to understand diseases by studying the patients who have them. You know you're doing patient-oriented research if you shake hands with the subject matter.

Patient-oriented research is rare. Most of biomedical research is basic. The focus is on a particular cellular process or molecule or on biotechnology, without regard to a disease. In disease-oriented research, the goal is to understand diseases, such as by animal models, genetic material from patients, or population studies. Within the domain of patient-oriented research, most of the activity is in designing, conducting, and reporting results of clinical trials of new treatments or in studying the natural history of disease—what happens to the patients over time with standard treatments. Patient-oriented research with the goal of understanding better the mechanisms of diseases is a rarity within a rarity.

Nevertheless, patients constitute a tremendous scientific resource. Only patients can tell you what and how they feel. It's the job of patient-oriented researchers to learn what their patients teach.

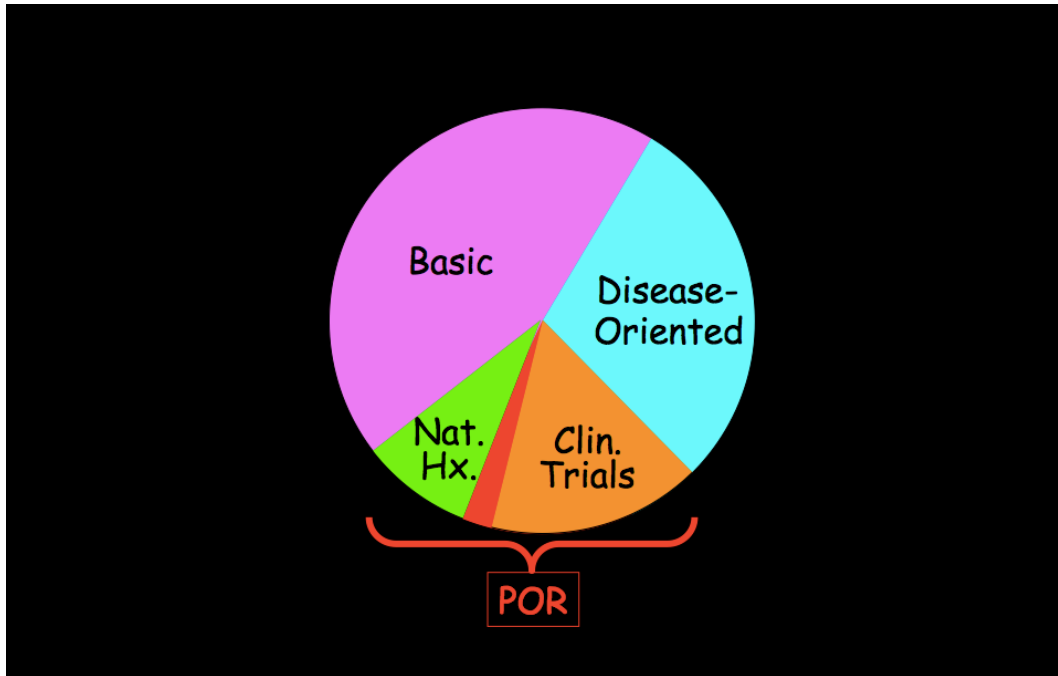

*Patient-oriented research is unusual. Patient-oriented research to understand disease mechanisms (the red sliver) is rare.*

## Why Did I Write this Book?

First, this textbook can be a vehicle for teaching clinical fellows at the NIH who are in our fellowship in autonomic disorders. The fellowship is accredited by the United Council for Neurological Subspecialties (UCNS). The textbook can help fellows pass the UCNS certifying examination.

Second, I wrote this textbook to highlight how catecholaminergic neuroimaging and neurochemistry inform about the diagnosis and pathophysiology of a variety of clinical autonomic disorders. Other textbooks do not go into these matters in depth, probably because several of the autonomic function tests conducted under research protocols in intramural NIH are not available elsewhere. Key neuroimaging and neurochemistry results often come in during the patients' inpatient workups, refining the diagnosis.

Third, this book teaches an integrative approach to autonomic medicine. The concepts of scientific integrative medicine, such as negative feedback regulation and homeostasis, are relatively simple and straightforward but nevertheless powerful for understanding clinical autonomic disorders. I believe dysautonomias provide a platform for linking systems biology with integrative pathophysiology.

Fourth, this textbook provides a unique and novel resource that patients, students, clinicians, and academicians can share. Through it I hope to help “flip the clinic,” empowering and giving responsibility to patients with autonomic disorders.

## **What is Different about this Book?**

There are advantages and disadvantages of having a single writer for a textbook such as this. An advantage is consistency. I believe that



over the years I've developed a uniform, integral approach, which can be applied to the diagnosis, pathophysiology, biomarkers, mechanisms, natural history, and treatment and prevention of autonomic and catecholamine-related disorders.

Having a single writer enhances legibility. There are different styles of expository writing. I think it is valuable to learn the point of view of a single writer, presented in a consistent way across chapters.

In this textbook I've tried to exploit a talent for drawing and cartooning to convey concepts that are difficult to learn from the text alone.

Probably the main distinction of this book is that I've designed it to be a resource that can be shared by patients, students, clinicians, and academicians. This is a tall order because of the obvious differences in competencies, vocabulary, and needs and expectations across these readerships.

The text highlighted in blue is for lay people and patients.

The Figures in this book are mainly concept diagrams. The Figure legends convey the key teaching points.

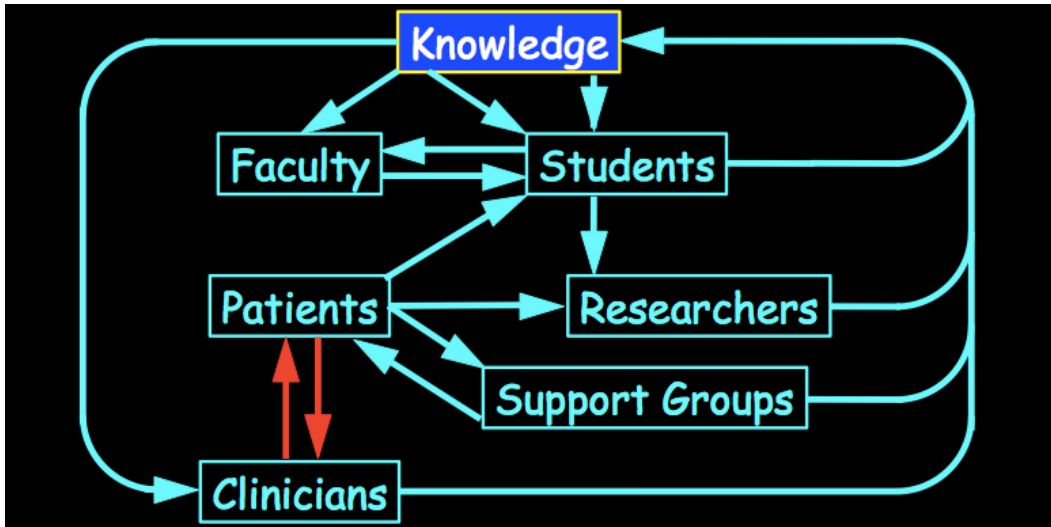

*This book is predicated on the notion that in medicine we can all learn from each other.*

For instance, in the Figure above, the arrows show the reciprocal influences and feedback loops among stakeholders in autonomic medicine. Patients teach clinicians (“flipping the clinic”), and clinicians teach patients; support groups provide demographic information, and they relay news to patients; faculty learn from students about how to teach and students learn from faculty. Each group enhances knowledge, which in turn informs all the others.

## **Dysautonomias and Catecholamines**

This textbook is founded on two pillars—dysautonomias and catecholamines.

This book covers two major areas of medical knowledge. Dysautonomias are disorders. Catecholamines are chemicals that are related to those disorders.

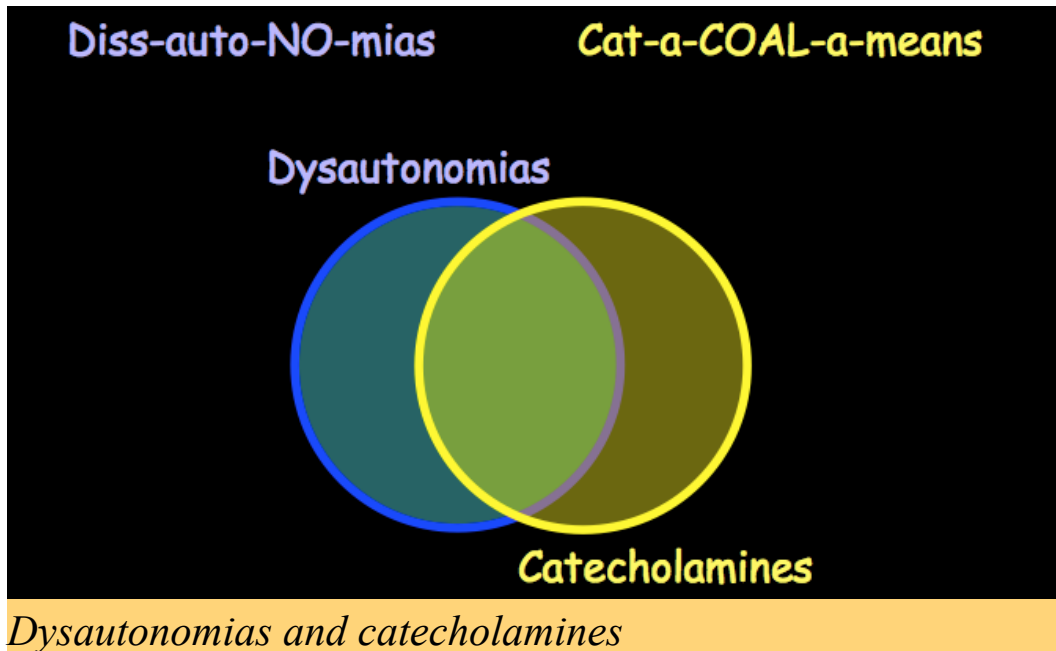

Unfortunately, both the disorders and the chemicals have names that are hard to pronounce.

The group of disorders are dysautonomias, pronounced diss-auto-NO-mias. As you'll be learning in great detail, dysautonomias are conditions in which there is a problem with functioning of the automatic part of the nervous system.

Catecholamines, pronounced cat-a-COAL-a-means (or if you're British, cat-a-call-AY-means). Catecholamines are members of a small family of body chemicals, the most famous member of which is adrenaline.

The reason for the overlap in these topics is that key parts of the automatic nervous system use catecholamines as their chemical messengers.

By measuring levels of the messengers, we can learn about how those parts work in health and disease.

There are a large number of conditions in which one or more components of the autonomic nervous system malfunction, called dysautonomias. We'll be getting to catecholamines somewhat later on.

## **Why are Dysautonomias So Hard?**

Dysautonomias are a difficult subject, for patients, doctors, students, and researchers. They are difficult to live with, diagnose and treat, and understand.

Whether you are a lay person, a patient, a caregiver, a student, a general physician, or even a specialist in neurology, cardiology,

endocrinology, or psychiatry, my guess is that the field of dysautonomias is almost completely foreign to you.

There are several reasons for this. I think it's important at the outset to explain why the field of dysautonomias is so hard.

## **Dysautonomias are Multi-Disciplinary**

The field of dysautonomias spans multiple disciplines of medicine. Specialists certified in programs in single disciplines often cannot serve dysautonomia patients.

If your only tool is a hammer, the world looks like a nail. If a dysautonomia patient sees a cardiologist, the cardiologist looks for an abnormal heart rhythm or heart block, something a pacemaker or ablation can treat. If the patient sees a neurologist, the neurologist looks for a seizure disorder, a problem with blood flow to the brain, or a brain structural abnormality. If the patient sees an endocrinologist, the endocrinologist looks for diabetes or a thyroid, adrenal, or pituitary problem. If the patient sees an immunologist, the immunologist looks for auto-immunity or mastocytosis. If the patient sees a gastroenterologist, the gastroenterologist looks for gastro-esophageal reflux, decreased gut motility, or irritable bowel syndrome (yet prescribing a high fiber diet could increase splanchnic pooling of blood and worsen orthostatic intolerance). If as often happens the patient finally sees a psychiatrist, the psychiatrist looks for depression, anxiety, or panic disorder.

**Cardiology** (heart rhythm, rate, block, failure, hypertension)

**Neurology** (seizures, Parkinson's, Chiari, neuropathy)

**Endocrinology** (diabetes, thyroid, adrenal)

**Gastroenterology** (esophageal, IBS, slow GI transit)

**Psychiatry** (depression, anxiety, conversion reaction)

**Pediatrics** (POTS, syncope, inherited/congenital)

**Pain Medicine** (migraine, fibromyalgia, neuropathic pain, TMJ)

**Immunology** (Sjogren's, auto-immune, mastocytosis)

*Dysautonomias are multi-disciplinary.*

Dysautonomias are Integrative

Many factors determine levels of pulse rate, blood pressure, body metabolism, pain, fatigue, and the sense of psychological well-being. These factors interact complexly with each other.

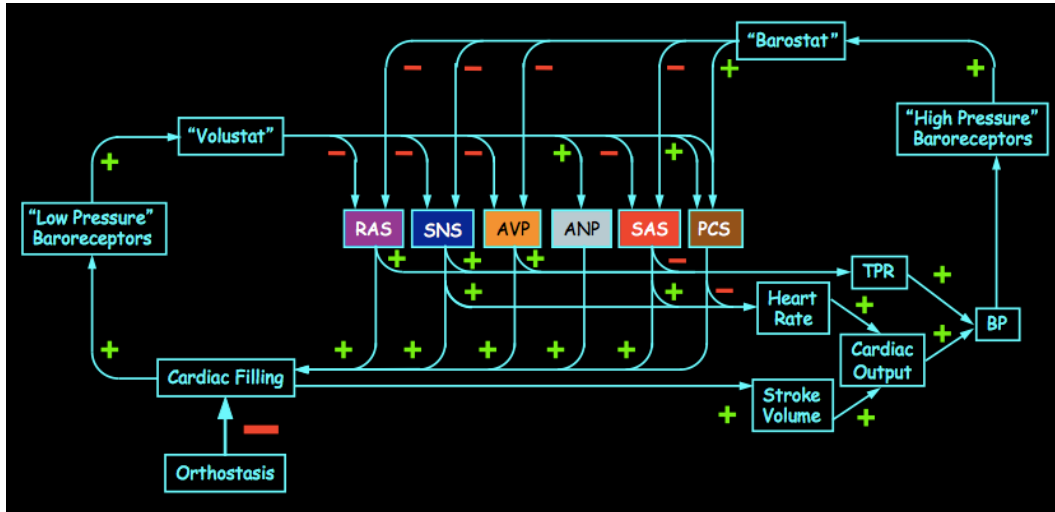

*Dysautonomias are integrative medical disorders. They involve many complex networks, effector systems, and feedback loops.*

Further complicating the picture, patients with dysautonomias often are treated with multiple drugs, which not only can interact with each other but also with the disorders. Scientific theories taking this complexity into account have lagged behind.

Diagrams depicting disorders of feedback regulated systems can appear dauntingly complex. At their core, though, as you will learn, they all involve abnormal functioning of negative feedback loops. This book teaches that dysautonomias are disorders of integration, of regulation, of systems that change during life as a function of the balance of wear and tear vs. resilience.

When it comes to research, partly because of the multi-disciplinary nature of dysautonomias, peer-review committees tend to view grant applications about dysautonomias as somewhat foreign or of secondary importance. The NIH is a major source of funding in American biomedicine, and clinical disorders of the autonomic nervous system don't fit well under the umbrella of any NIH Institute. Considering the public health burden posed by dysautonomias, research funding in an attempt to reduce that burden is remarkably scarce.

## Dysautonomias are Mind-body Disorders

Are dysautonomias in the mind or body? The answer is: both.

Dysautonomias are “mind-body” disorders, which goes against a distinction between mental and physical body processes. It is unhelpful to classify dysautonomias—or the patients suffering with them—as “psychiatric” or “medical.”

A major purpose of this book is to teach that the many symptoms of dysautonomias reflect real biological or chemical changes. If a clinician cannot identify the cause of a patient's symptoms, this ignorance should not lead to dismissing the patient as having a psychiatric rather than a “real” problem.



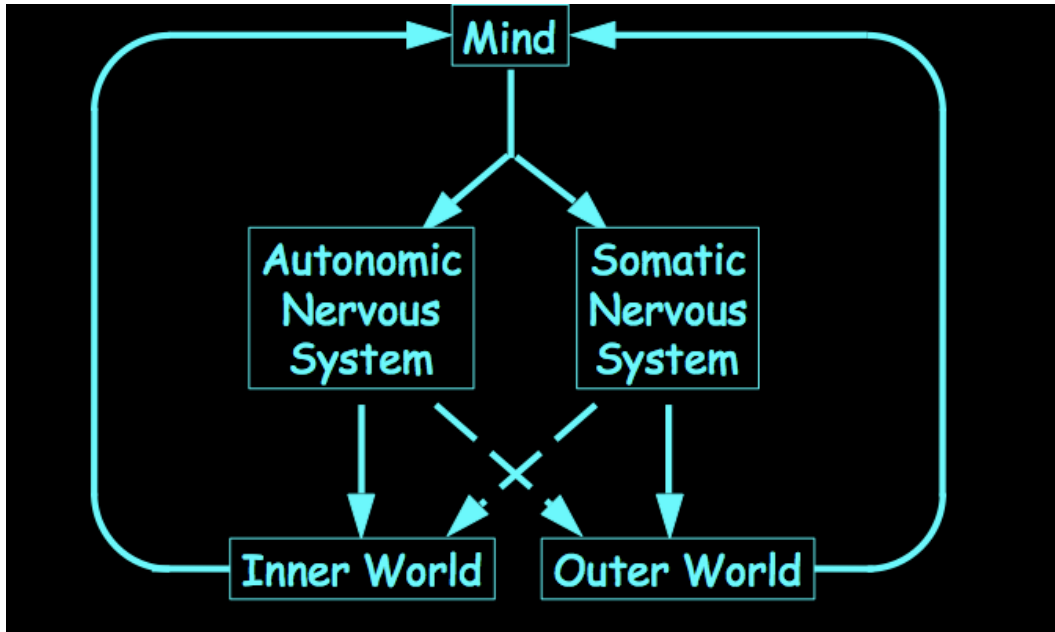

*Dysautonomias are mind-body disorders.*

Medical tradition separates mental from physical illness. Distinctions between the “body” and the “mind,” the physical and mental, problems imposed on the individual and those in the mind of the individual, are unhelpful in trying to understand dysautonomias. The autonomic nervous system operates at the border of the mind and body. In this course you will learn a systems approach to the mind-body issue.

## Different Centers have Different Emphases

In almost every aspect of dysautonomias practice and research,

Valsalva Beat-to-beat BP  
Tilt table testing  
Sweat testing (QSART, TST)  
Power spectral analysis of HRV  
Skin biopsies & neuropathology (PGP 9.5)  
Plasma catechols (catecholamines, DHPG, DOPAC, DOPA)  
Cardiac sympathetic neuroimaging (MIBG, F-DA)  
Immunology (anti-nAChR)  
Striatal dopaminergic neuroimaging (F-DOPA, DATscan)  
Pupillometry

*Different centers have different emphases and offer different batteries of autonomic function tests.*

doctors—even experts in the field—can disagree, about key questions. How should dysautonomias be classified? What are the types and subtypes? Of what do patients with particular dysautonomias complain? Which tests are useful to diagnose particular dysautonomias or monitor responses to treatments? Which treatments work for which forms of dysautonomia? What happens to patients with dysautonomias over time?

Different centers have different emphases in the workup and management of dysautonomias. One center traditionally has focused on familial dysautonomia, a rare pediatric disease. Another has emphasized dysautonomia associated with diabetes, another disorders of sweating, another chronic orthostatic intolerance and multiple system atrophy, and another autoimmune autonomic ganglionopathy.

Different centers also offer different tests, often depending on factors such as finances and insurance coverage. In my opinion these aspects have impeded the adoption and application of valuable, powerful clinical laboratory technologies. No center outside the NIH has an integrated program of neuroimaging and neurochemistry. Tests done at the NIH are usually for research purposes, meaning they are not approved by the FDA as diagnostic tests and are not covered by insurance.

## Dysautonomias are Not Taught Well

Dysautonomias are not taught well, at any level of education.

A major reason I wrote this textbook is that the field of clinical disorders of the autonomic nervous system is not taught well—if at all—at any educational level.

Medical and graduate school curricula rarely contain coursework on dysautonomias. Clinical and basic training and scientific knowledge

about dysautonomias are disproportionate compared to the large patient demand.

The recent accreditation by the United Council for Neurologic Subspecialties (UCNS) of fellowships in autonomic disorders is a good first step. As of this writing, however, there are only four accredited programs.

I hope this book will be useful for patients, students, clinicians, and academicians. Because of the different readerships with very different levels of education and experience and needs and expectations, writing this book has posed challenges. I have tried to meet them as follows.

The text highlighted in blue is taken in large measure from my book, *Dysautonomias: A Handbook for Patients*. Hopefully, lay people, patients, and caregivers will be able to comprehend the highlighted text. At the end of the book is a large glossary.

To help students and trainees grasp the scientific concepts, I've used several analogies and drawn many figures and diagrams. The figure legends in italics provide a kind of parallel text. To keep up interest, there are many historical perspectives, anecdotes, vignettes of individual cases—even novel interpretations of bible stories.

For clinicians there are descriptions of several autonomic function

tests, recognizing that the most informative test is an intelligently obtained medical history. I've also included concepts underlying several treatments, recognizing that management of autonomic disorders should be tailored to the individual condition and patient and that reassurance, accurate information, and empathy often are at least as effective as drugs.

For academicians I'm proposing a few ideas that seem to me to have potential for enhancing understanding of autonomic and catecholamine-related disorders. Some of these ideas are catecholamine autotoxicity, allostatic load, and scientific integrative medicine, to link systems biology with integrative physiology.

Having one textbook on autonomic medicine as a knowledge base for several readerships may be a first step toward "flipping" the classroom and clinic. By this I mean giving students more power and responsibility in their education and giving patients more power and responsibility in their clinical management. We all can and should learn from each other.

Please let me know if this book works for you, at [goldsteind@ninds.nih.gov](mailto:goldsteind@ninds.nih.gov).

slows down, and the heart beats less forcefully.

There are inhibitory muscarinic receptors on sympathetic post-ganglionic nerves in the heart. Because of this, vagal stimulation decreases the rate and force of cardiac contraction, not only directly by the released acetylcholine acting at muscarinic receptors on the target myocardial cells, but also indirectly by inhibiting norepinephrine release from sympathetic post-ganglionic nerves.

In some forms of dysautonomia, multiple components of the autonomic nervous system are affected similarly. For instance, interference with the transmission of nerve impulses in the ganglia produces symptoms and signs of failure of the sympathetic noradrenergic system, the sympathetic cholinergic system, the sympathetic adrenergic system, and the parasympathetic nervous system.

In other situations, increases in activities of these systems go together. An example is after eating a meal. In this setting, stimulation of the parasympathetic nervous system aids digestion, by increasing gut motions and augmenting secretions of hormones, such as insulin. Meanwhile, stimulation the sympathetic noradrenergic system tightens blood vessels in some body regions, shunting blood toward the gut. After a meal, possibly because of increased levels of glucose in the bloodstream, activity of the sympathetic adrenergic system tends